

1、适用范围与用途/ Application Scope and Purpose

NDZ3X-50~300 系列直流接触器适用于工作电压至 DC1000V，工作电流为 50~300A 的直流系统中，主要用于充电桩、充电站、光伏等领域。

The NDZ3X-50~300 series of DC contactors apply to the DC system with the working voltage of DC1000V and working current of 50~300A, which are mainly used in charging piles, charging stations, photovoltaic and other fields.

2、产品图片/ Picture of the Product



NDZ3X-50B/50/100B/100



NDZ3X-150



NDZ3X-150J/200/250/300

3、规格型号说明/ Specification and Model Description

ND
Z
3

-

1 2 3 4 5 6 7 8

| 序号/ No | 序号名称/ SN name | NDZ3 |
|--------|------------------------------------|--|
| 1 | 企业代号 Enterprise code | ND “Nader”牌低压电器 ND "Nader" brand low-voltage electrical device |
| 2 | 产品代号 Product code | Z 直流接触器 Z DC contactor |
| 3 | 设计代号 Design SN | 3 |
| 4 | 系列派生代号 Series derivation code | X: 高性能产品 X: High-performance product |
| 5 | 基本规格代号 Basic specification code | 额定电流值 Rated current |
| 6 | 辅助触头数量 Auxiliary contact code | 空白: 无辅助触头, 10: 带一组常开辅助触头, 01: 带一组常闭辅助触头, 11: 带一组常开和一组常闭辅助触头 Blank: Without auxiliary contacts, 10: With a group of NO auxiliary contacts, 01: With a group of NC auxiliary contacts, 11: With a group of NO and NC auxiliary contacts |
| 7 | 特殊代号 Special code | 空白: 常规产品 J: 节电型产品 |



| | | |
|---|----------------------|--|
| | | B: 高尺寸产品 Blank: Conventional product J: Power-saving product B: High size product |
| 8 | 线圈电压 Coil voltage | DC12V、DC24V、DC48V、DC9V~36V |

注 1: NDZ3X-50B/50/100B/100/150 线圈电压有 DC12V、DC24V、DC48V 三种; NDZ3X-150J/200/250/300 线圈电压为 DC9~36V

Note 1: The NDZ3X-50B/50/100B/100/150 coil voltage is available with DC12V, DC24V and DC48V; the NDZ3X-150J/200/250/300 coil voltage is DC9~36V.

4、主要技术参数/ Main Technical Parameters

| 型号 Model 参数 Parameter name | NDZ3X-50 | NDZ3X-50B | NDZ3X-100 | NDZ3X-100B | NDZ3X-150 | NDZ3X-150J | NDZ3X-200 | NDZ3X-250 | NDZ3X-300 |
|--|--|-----------|------------------------------|------------|------------------------------|------------|--------------------------------|--------------------------------|--------------------------------|
| 额定电流 Rated current | 50A | | 100A | | 150A | | 200A | 250A | 300A |
| 约定自由空气发热电流 I _{th} Agreed thermal current of the free air I _{th} | 150A | | | | 300A | | 500A | | |
| 额定电压 Rated voltage | DC750V | | | | | | | | |
| 绝缘电压 U _i Insulation voltage U _i | DC1000V | | | | | | | | |
| 极数 Number of poles | 单极 Single pole | | | | | | | | |
| 电路种类 Type of circuit | 直流 DC | | | | | | | | |
| 机械寿命 Mechanical life | 100 万次, 频率 1200 次/小时 1,000,000 times, frequency 1200 times/h, | | | | | | | | |
| 电气寿命 (DC-1, 360 次/小时, 1s 通, 9s 断, 正向) Electrical life (DC-1, 360 times/h, 1s on, 9s off, forward direction) | DC750V 50A 2000 次 /times | | DC750V 100A 2000 次 /times | | DC750V 150A 2000 次 /times | | DC750V 200A 2000 次/times | DC750V 250A 2000 次/times | DC750V 300A 1500 次/times |
| 最大切断电流: Maximum breaking current: | DC320V 1000A 1 次/once | | | | DC320V 2000A 1 次/once | | | | |
| 短路耐受电流: Short-circuit withstand current: | 750A 30ms | | 1500A 30ms | | 2250A 30ms | | 3000A 30ms | 3750A 30ms | 3750A 30ms |

| | | |
|---|---|---|
| 绝缘电阻: Insulation resistance: | ≥100MΩ, DC500V | |
| 耐压: Withstand voltage : | AC2500V 60s | AC3500V 60s |
| 额定控制电压Uc Rated control voltage Uc | 额定电压/ Rated control voltage: DC12/24V/48V 动作范围/ Pick-up voltage: 75%~110%Uc 释放范围/ Drop-out voltage: 10%~60%Uc | 额定电压/ Rated control voltage: DC 12V~24V 动作范围/ Pick-up voltage: DC 9V~36V 释放范围/ Drop-out voltage: DC1.2V~DC7.2V (冷态/Cold state ≥-40℃) |
| 最大启动电流 (20℃) Maximum pull-in current (20℃) | ≤0.5A | ≤3.5A |
| 保持功耗 (常温20℃, 额定电压控制): Retention power consumption (20℃, Rated voltage control): | ≤6W | ≤3.6W/3.6VA |
| 吸合/释放时间 (额定 电压): Pull-in/discharge time (rated voltage): | ≤35ms/15ms | ≤35ms/20ms |
| 辅助触头类型: Auxiliary contact type: | 无辅助, 1NO, 1NC, 1NC+1NO Without Auxiliary contact, 1NO, 1NC, 1NC+1NO 注2: NDZ3X-50/100无辅助触头 Note 2: NDZ3X-50/100 don't have auxiliary contact. | |
| 辅助触头电流: Auxiliary contact current: | 2A/DC30V, 3A/AC125V | |
| 辅助触头接通最小容 量: Minimum capacity of the auxiliary contact connecting: | 8V 100mA | |

5、电寿命曲线图/ Electrical Life Line Chart

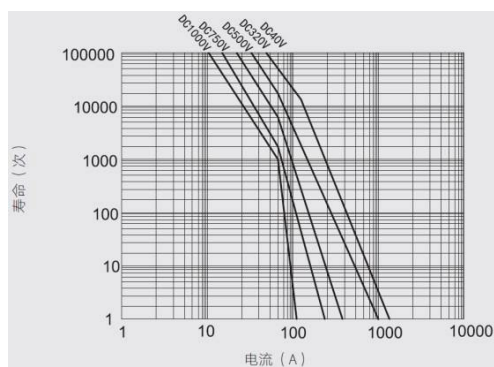

NDZ3X-50(B)

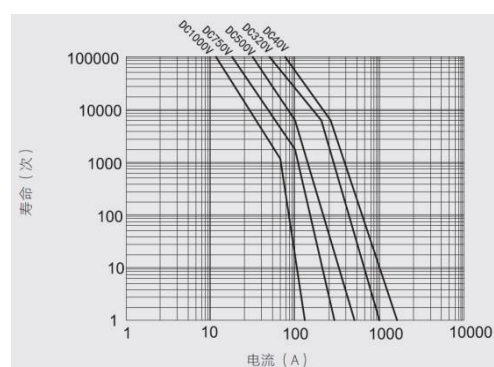

NDZ3X-100(B)

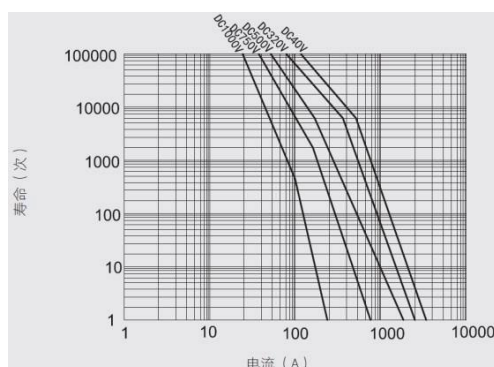

NDZ3X-150/150J

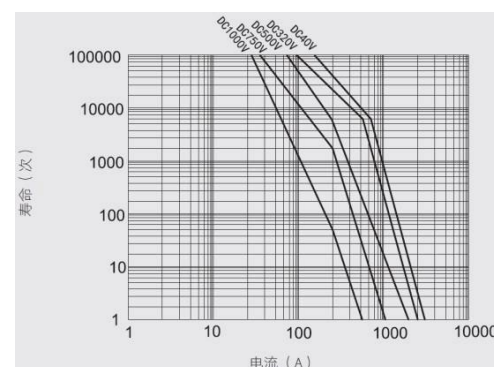

NDZ3X-200

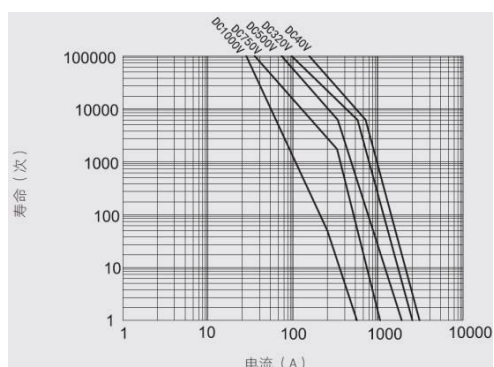

NDZ3X-250

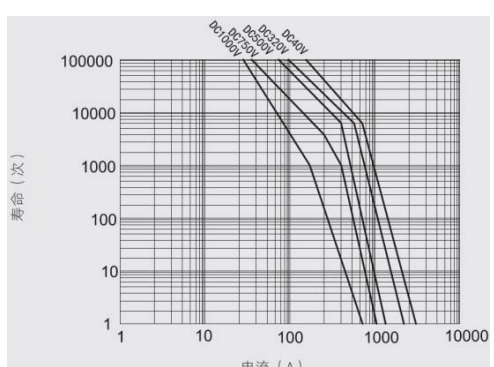

NDZ3X-300

注/Note: :

- a、产品额定电寿命次数基于阻性负载测试，其负载的最大电感不超过 300uH；有感负载咨询工厂。
- a. The rated electrical life of the product is based on the resistive load test, and the maximum inductance of the load shall not exceed 300uH. Feel load consulting factory.
- b、上图根据测试及推断数据的估算绘制，建议用户根据实际使用线路中进行测试确认。
- b. The figure above is drawn according to the estimation of test and inferred data. It is suggested the users conduct test confirmation according to the actual use circuit.
- c、当产品的介质耐压、绝缘电阻小于产品参数表中参数时，产品定义为寿命终结。
- c. When the dielectric withstand voltage and insulation resistance of the product are less than the parameters in the product parameter table, the product is defined as the end of life.

6、电流时间曲线图/ Current Time Line Chart

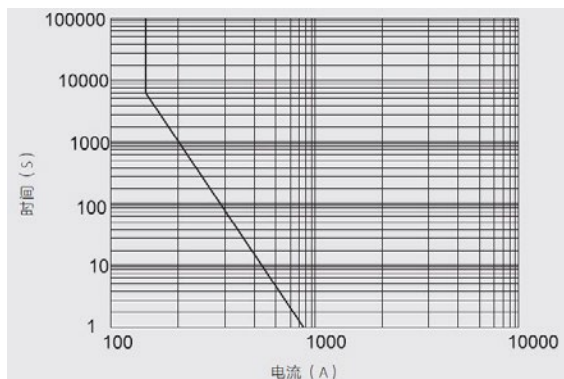

NDZ3X-50(B)

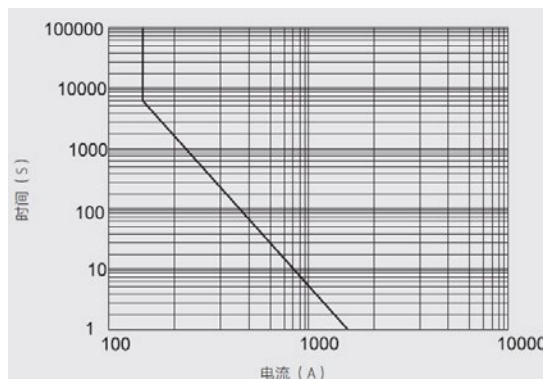

NDZ3X-100(B)

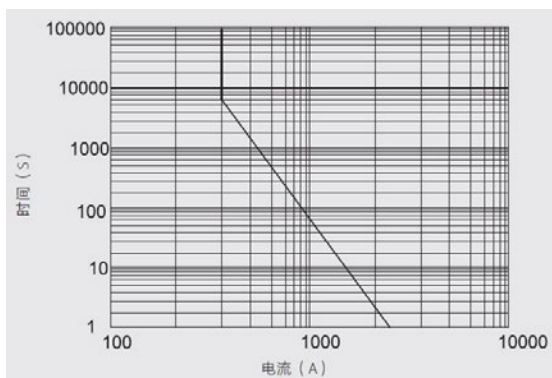

NDZ3X-150/150J

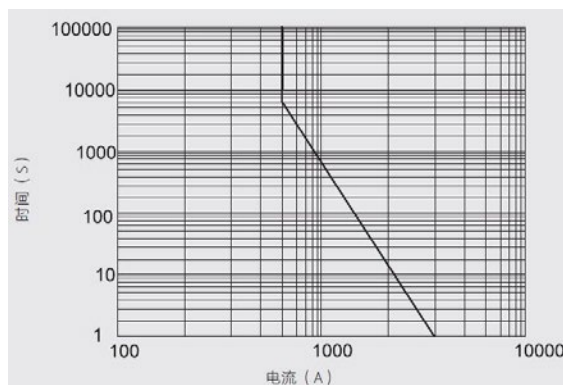

NDZ3X-200

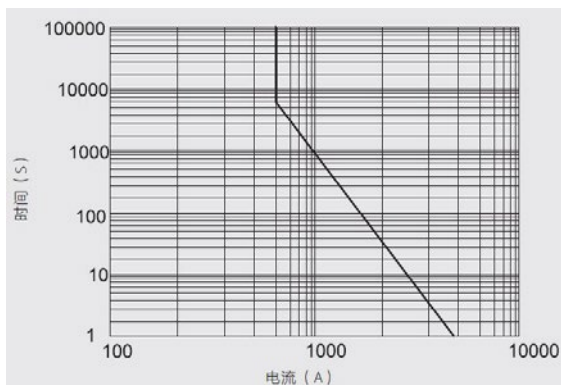

NDZ3X-250

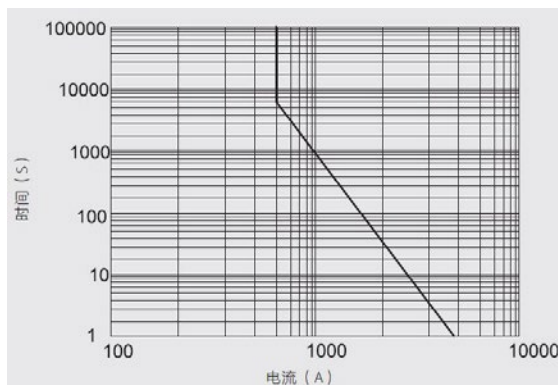

NDZ3X-300

7、正常工作环境/ Normal Working Environment

7.1: 工作环境温度/ Operating environment: $-40\sim 85^{\circ}\text{C}$

7.2: 工作湿度/ Operating humidity: 5%~95%

7.3: 污染等级/ Pollution level: 3

7.4: 防护等级/ Protection class: IP67 (接线端子除外/Except the connecting terminals)

7.5: 安装方向/ Installation direction: 垂直安装/Vertical installation

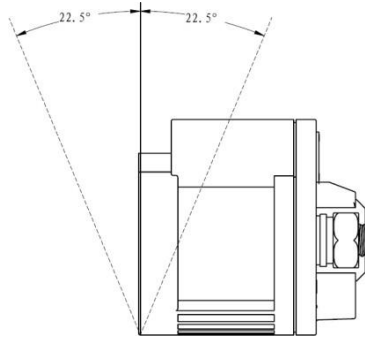

注：水平安装方式请与我司联系。

Note: for horizontal installation, please contact us.

7.6: 接线方式/Mode of connection:一字型接线/Straight line connection

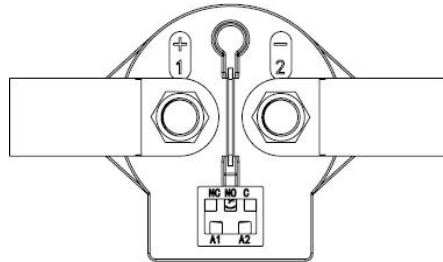

8

注：其他接线方式请与我司联系。

Note: for the others connection type, please contact us.

外形尺寸和安装尺寸/ External Dimensions and Installation Dimensions

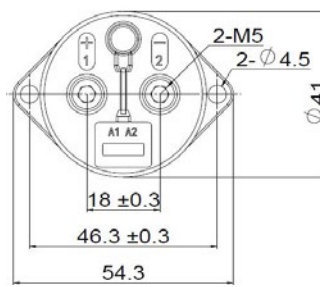
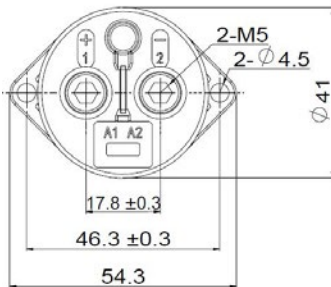
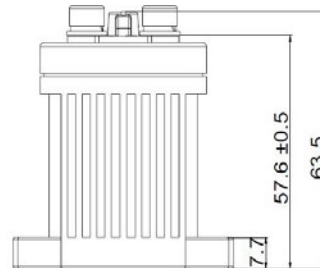
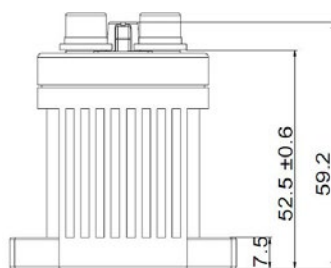

NDZ3X-50/100

NDZ3X-50B/100B

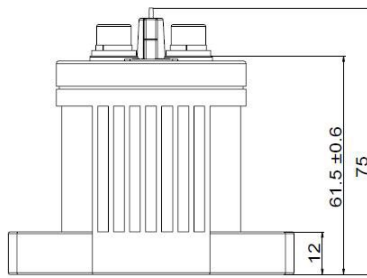

NDZ3X-150

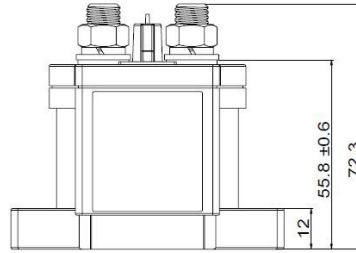

NDZ3X-150J/200/250/300

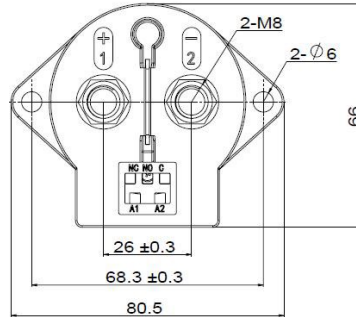
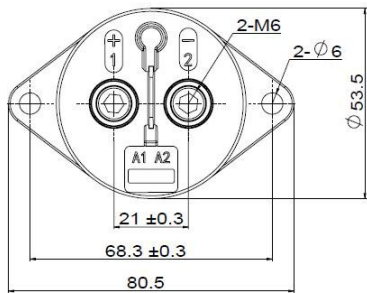

注/ Note::

1. 未注公差±1mm;
1. Unmarked tolerance ±1mm;
2. 线圈和辅助引出线常规线长为 320mm，另有特殊线长 390mm、800mm、1000mm，如有需要请与
我司联系;
2. The conventional wire length of the coil and auxiliary outgoing wire is 320mm, and the special wire
length is 390mm, 800mm and 1000mm. Please contact our company if you need;
3. 线圈和辅助引出线可另加端子连接器，型号请与我司联系。
3. Additional terminal connector can be added to the coil and auxiliary outgoing wire. Please contact our
company for the model.

9、安装方式/ Installation Mode

螺钉安装/ Screw mounting

10、环保符合性/ Environmental Compliance

符合 RoHS 指令/ Comply with the RoHS directives

11、注意事项/ Precautions

- a. 接触器线圈的驱动电路功率必须大于产品线圈起动功率;
- a. The drive circuit power of the contactor coil must be greater than the coil's starting power;
- b. 严禁在强磁场的地方或者靠近热辐射的范围内使用;
- b. It is strictly forbidden to use the product in places with strong magnetic fields or in proximity to
thermal radiation;
- c. 接线端子扭力矩 (NDZ3X-150J/200/250/300:M8 螺母): 7~8N.m, 安装螺丝扭力矩
(NDZ3X-150:M6 螺丝) 4~5N.m: , 安装螺丝扭力矩 (NDZ3X-50/50B/100/100B:M5 螺丝):
3.5~4.5N.m;
- c. Terminal torque (NDZ3X-150J/200/250/300:M8 nut): 7~8N.m, mounting screw torque



(NDZ3X-150:M6 screw) 4~5N.m: mounting screw torque (NDZ3X-50/50B/100/100B:M5 screw):
3.5~4.5N.m;

d、请避免在引出端上粘附油脂等异物，并使用以下规格的连接导线，否则有可能会造成引出端部分的异常发热；

d. Avoid adhering grease and other foreign matters on the exit and use the connecting conductor with the following specifications, which may otherwise lead to the abnormal heating of the exit part;

NDZ3X-50/50B: 导线截面积 $\geq 10\text{mm}^2$;

NDZ3X-50/50B: Wire cross-section area $\geq 10\text{mm}^2$;

NDZ3X-100/100B: 导线截面积 $\geq 35\text{mm}^2$;

NDZ3X-100/100B: Wire cross-section area $\geq 35\text{mm}^2$;

NDZ3X-150/150J: 导线截面积 $\geq 50\text{mm}^2$;

NDZ3X-150/150J: Wire cross-section area $\geq 50\text{mm}^2$;

NDZ3X-200: 导线截面积 $\geq 95\text{mm}^2$;

NDZ3X-200: Wire cross-section area $\geq 95\text{mm}^2$;

NDZ3X-250: 导线截面积 $\geq 120\text{mm}^2$;

NDZ3X-250: Wire cross-section area $\geq 120\text{mm}^2$;

NDZ3X-300: 导线截面积 $\geq 185\text{mm}^2$;

NDZ3X-300: Wire cross-section area $\geq 185\text{mm}^2$;